

**Exercício 4**  
**Desenho Técnico Mecânico – Vistas Essenciais**

Aluno:

Curso:

Data:

3. Complete, à mão livre, as projeções das peças apresentadas.

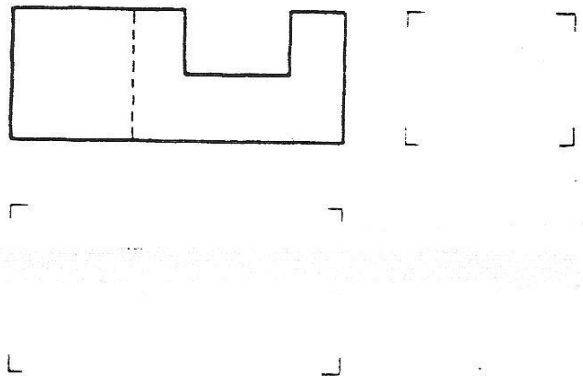
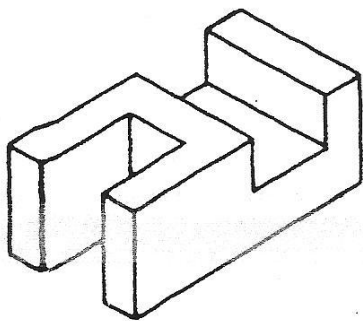
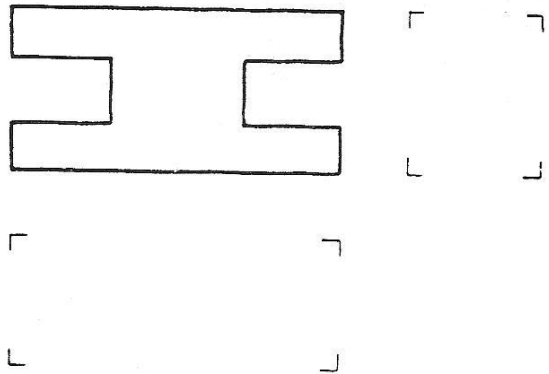
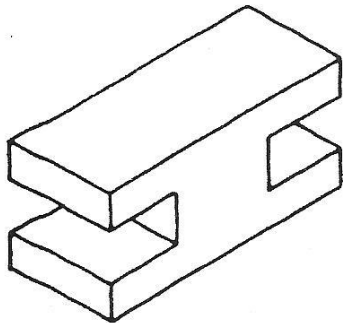
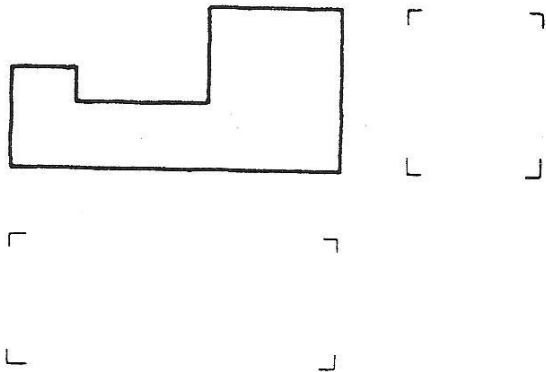
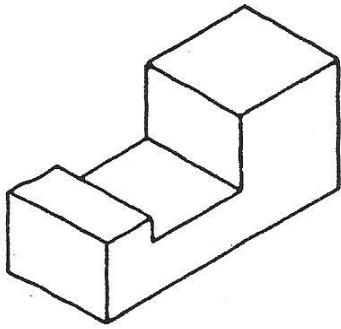

### Exercício 4

#### Desenho Técnico Mecânico – Vistas Essenciais

Aluno:

Curso:

Data:

3. Complete, à mão livre, as projeções das peças apresentadas.

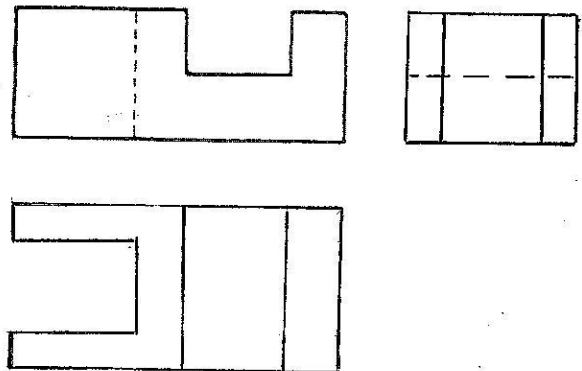
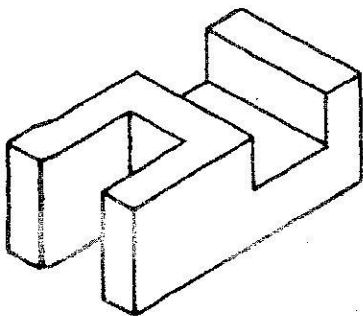
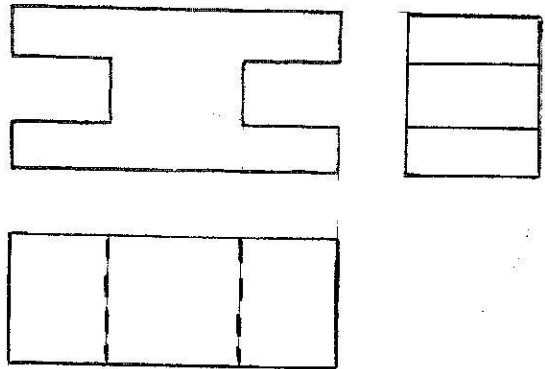
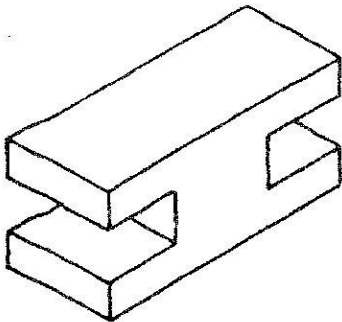
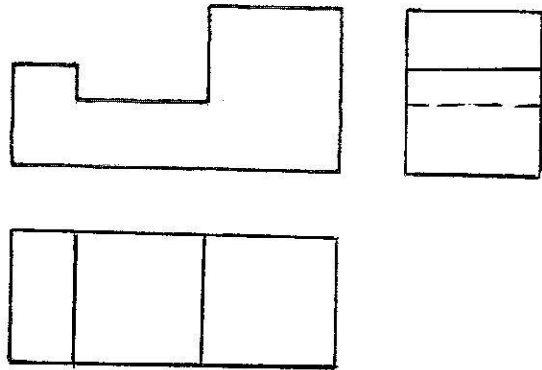
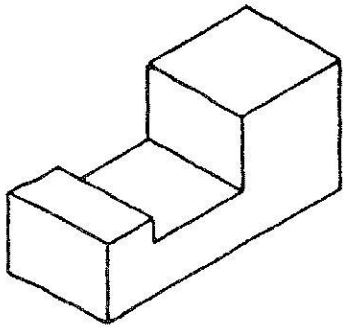

## Exercício 5

### Desenho Técnico Mecânico – Vistas Essenciais

Aluno:

Curso:

Data:

7. Identifique e numere as projeções correspondentes a cada peça apresentada em perspectiva.

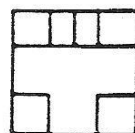
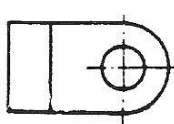
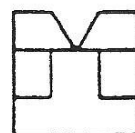
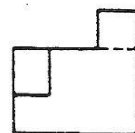
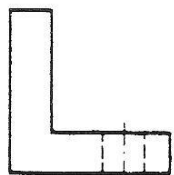
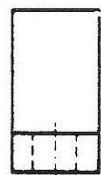
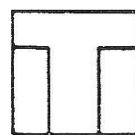
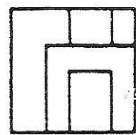
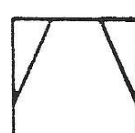
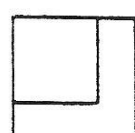
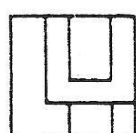
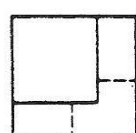
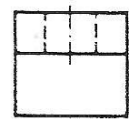
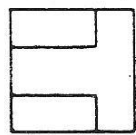
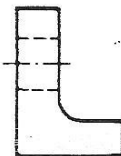
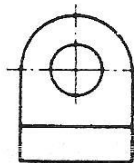
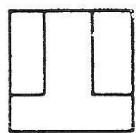
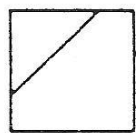
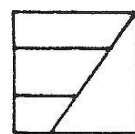
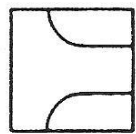
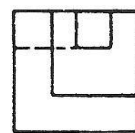
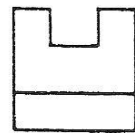
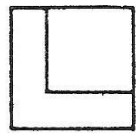
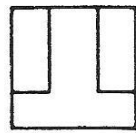
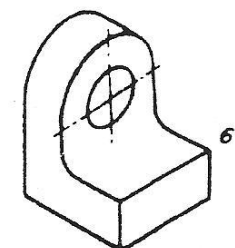
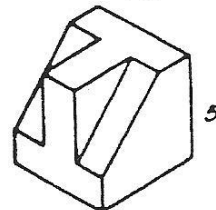
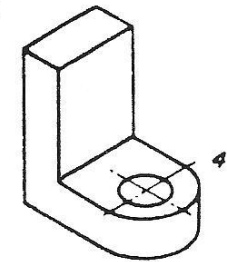
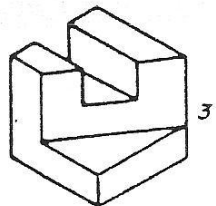
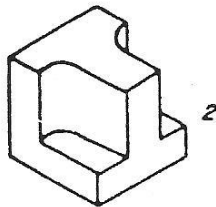
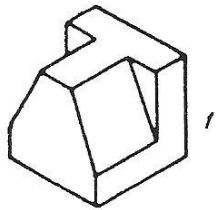

## Exercício 5

### Desenho Técnico Mecânico – Vistas Essenciais

Aluno:

Curso:

Data:

7. Identifique e numere as projeções correspondentes a cada peça apresentada em perspectiva.

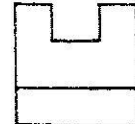
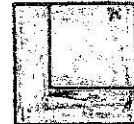
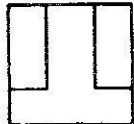
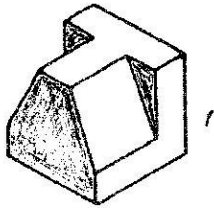

2

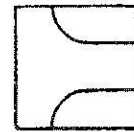

3

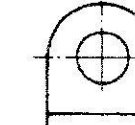
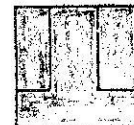
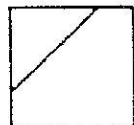
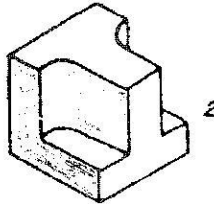
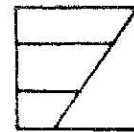

2

5

6

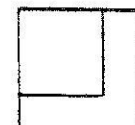
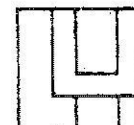
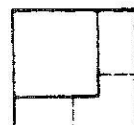
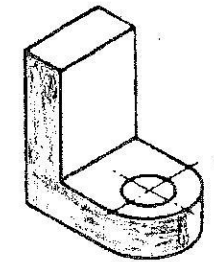
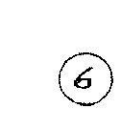
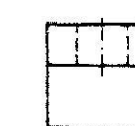
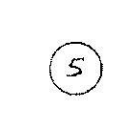
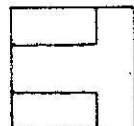
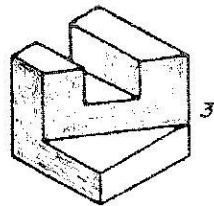

4

1

1

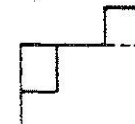
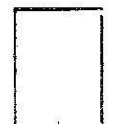
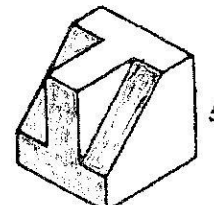

5

4

1

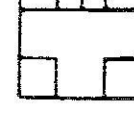
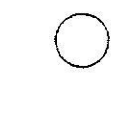
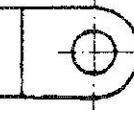
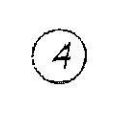
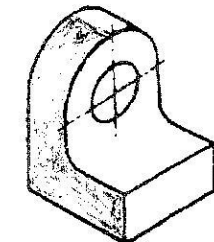

6